

RESTORATION PROJECT AT BUFFALO BY
WWW.ASIANSTONES.COM

The Building



Some Before and After pictures with new replicated stones to replace the old broken and worn out pieces with corresponding CAD Drawings

Before

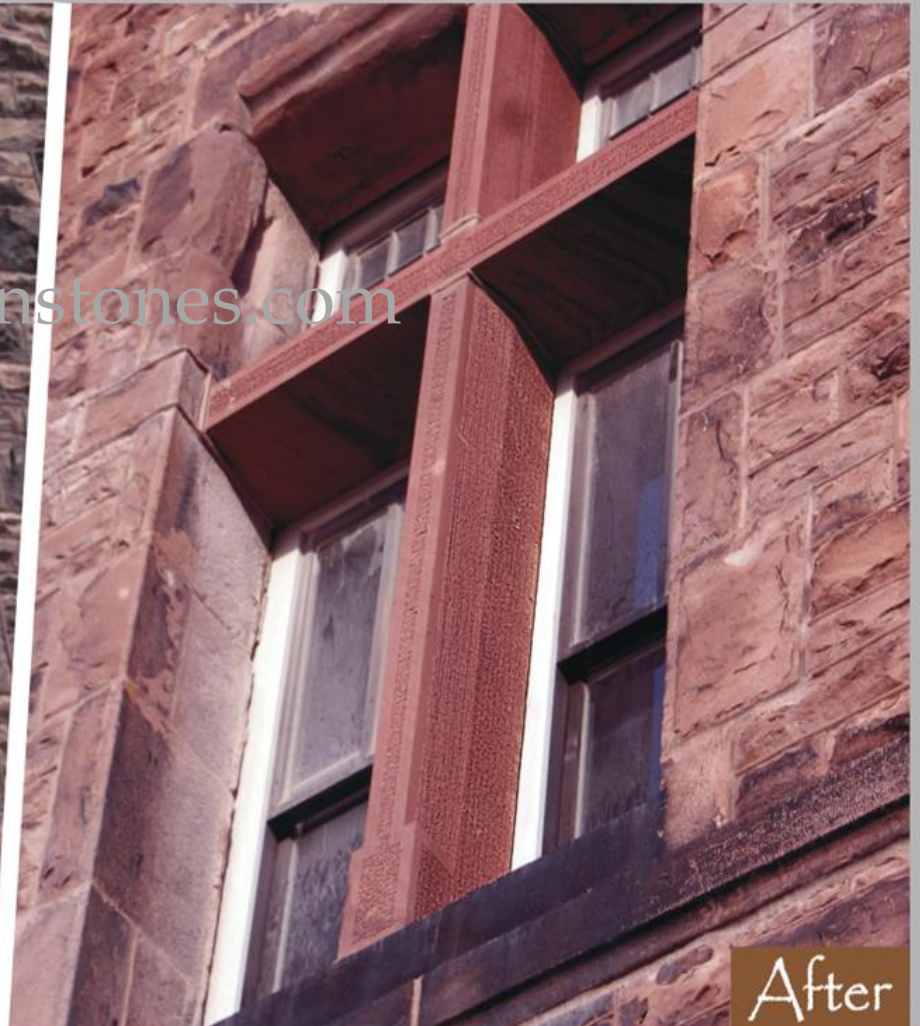
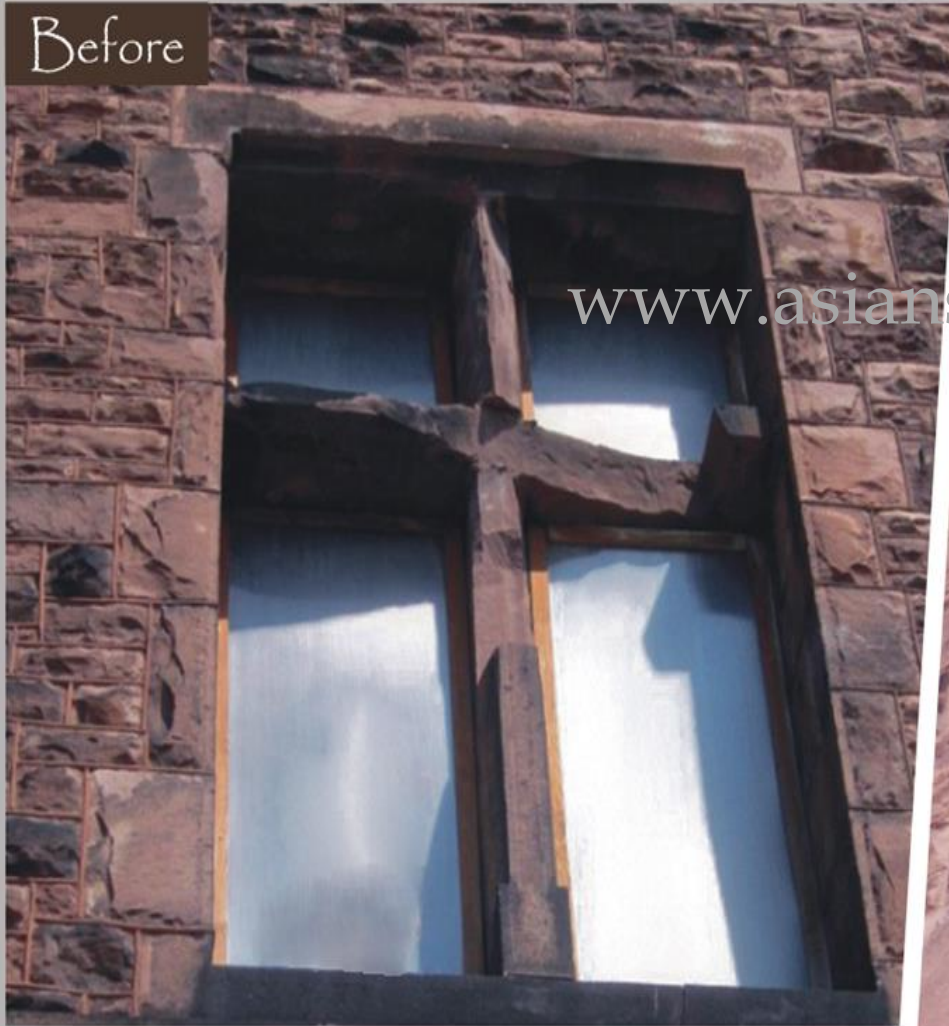

After

Niche Sill

Before



After

Niche Sill Drawing

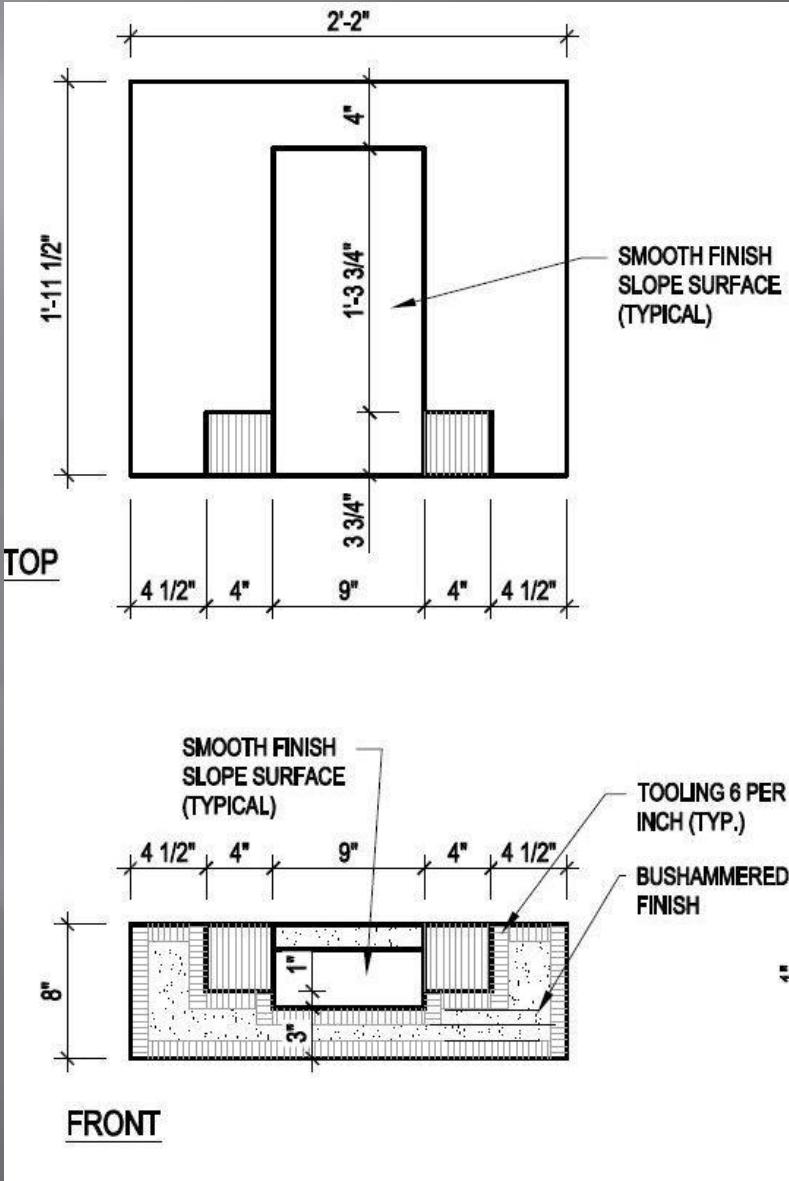

Mullion and Sill

Before

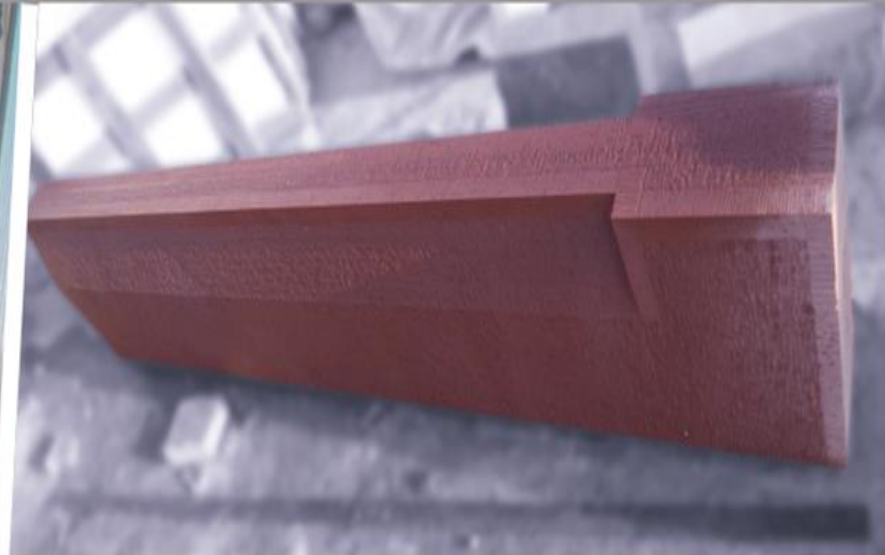

www.asianstones.com



After

Mullion and Sill Drawing

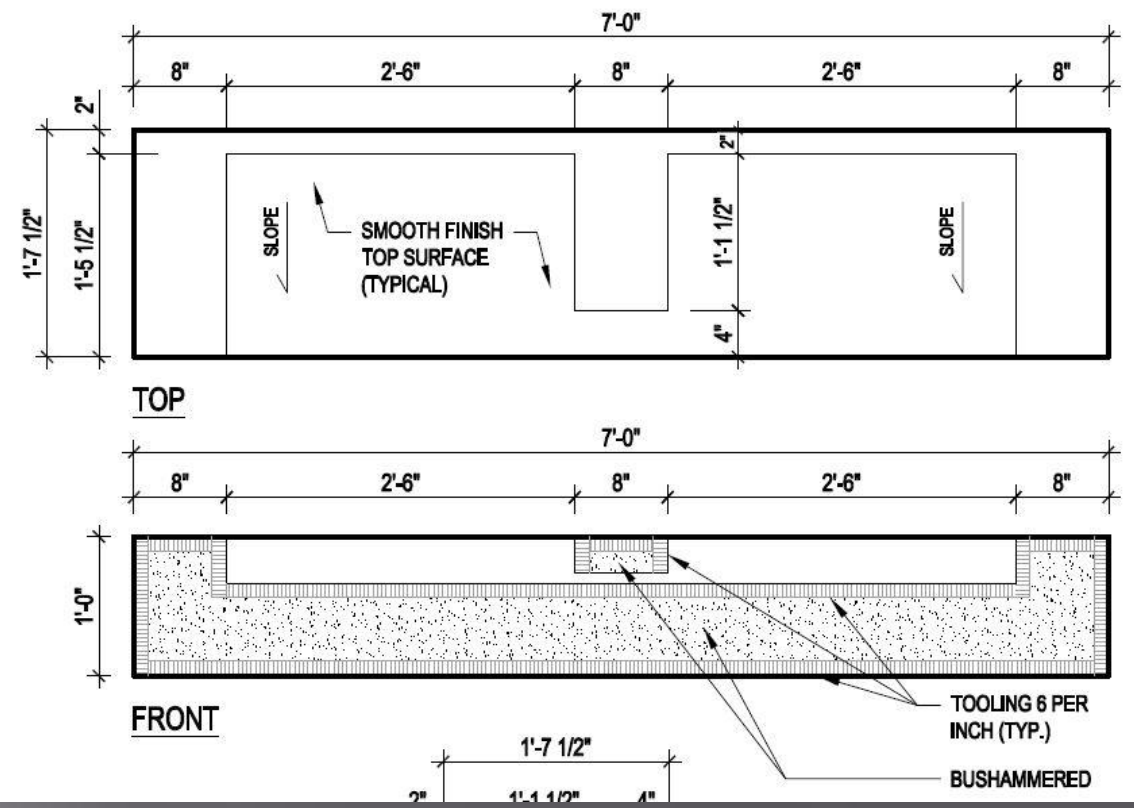
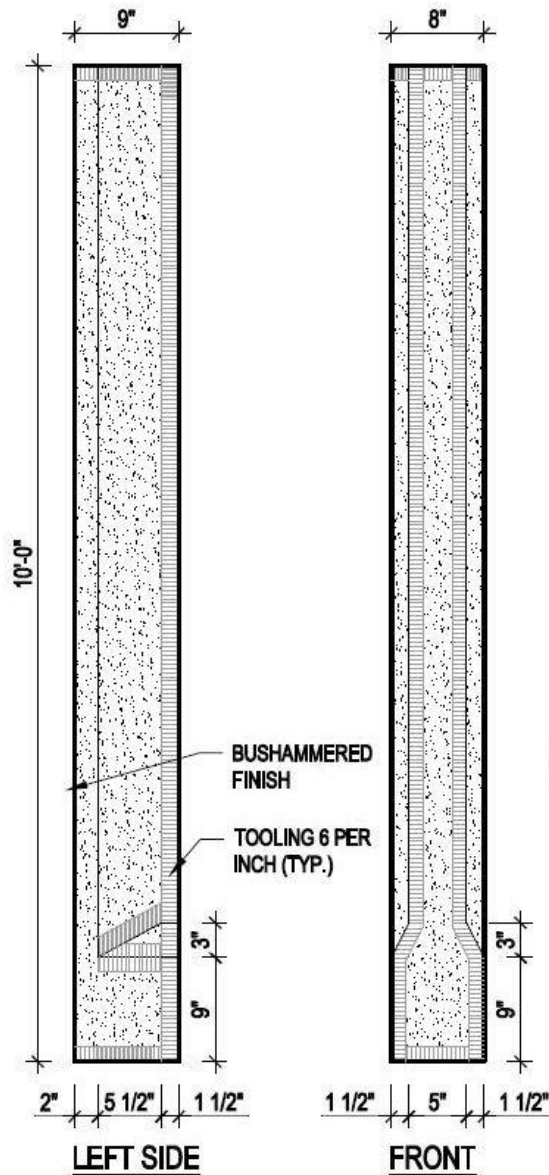

Dentils

Before



www.asianstones.com



After

Dentil Drawing

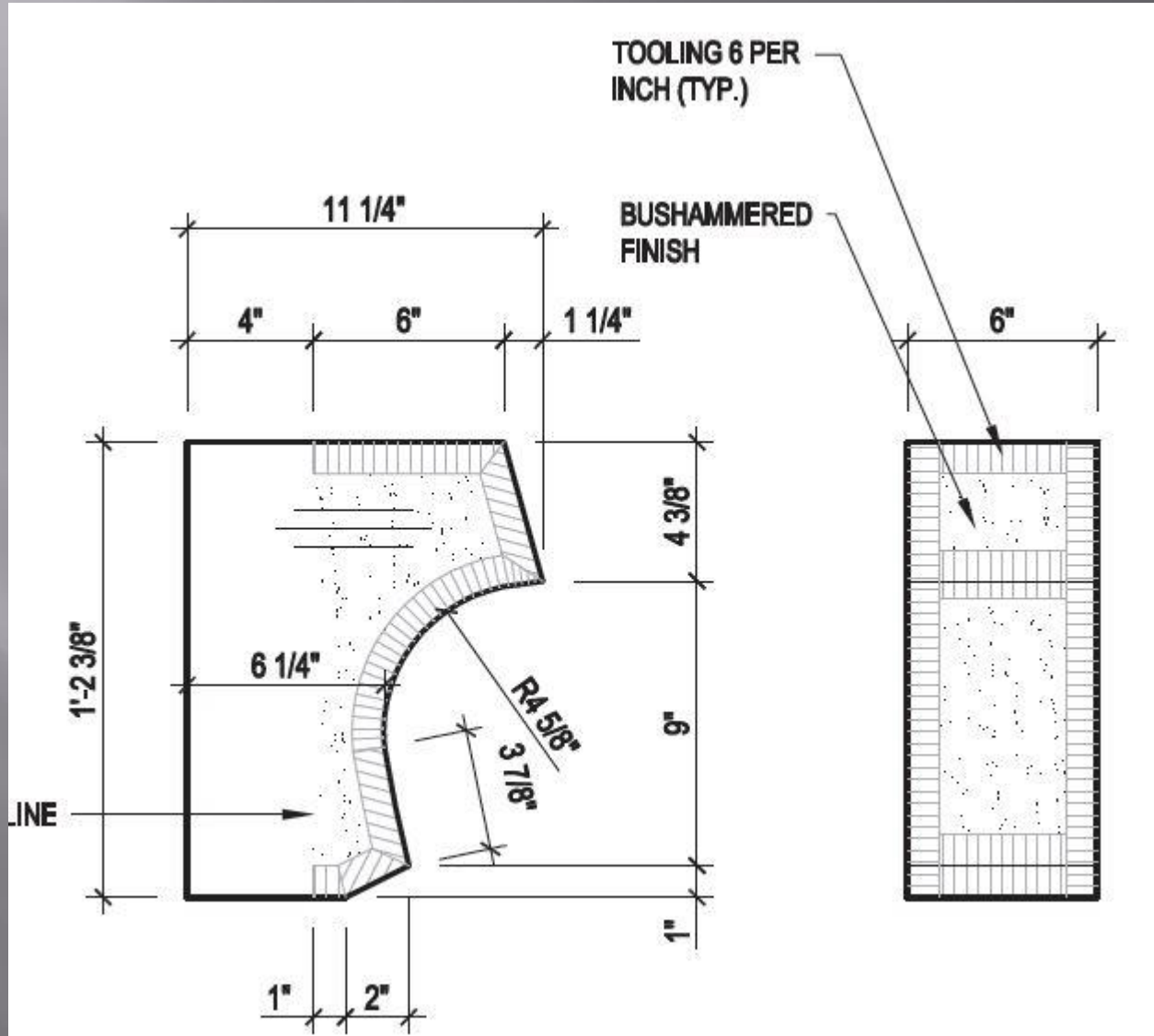

Quoins and Window Lintels

Before

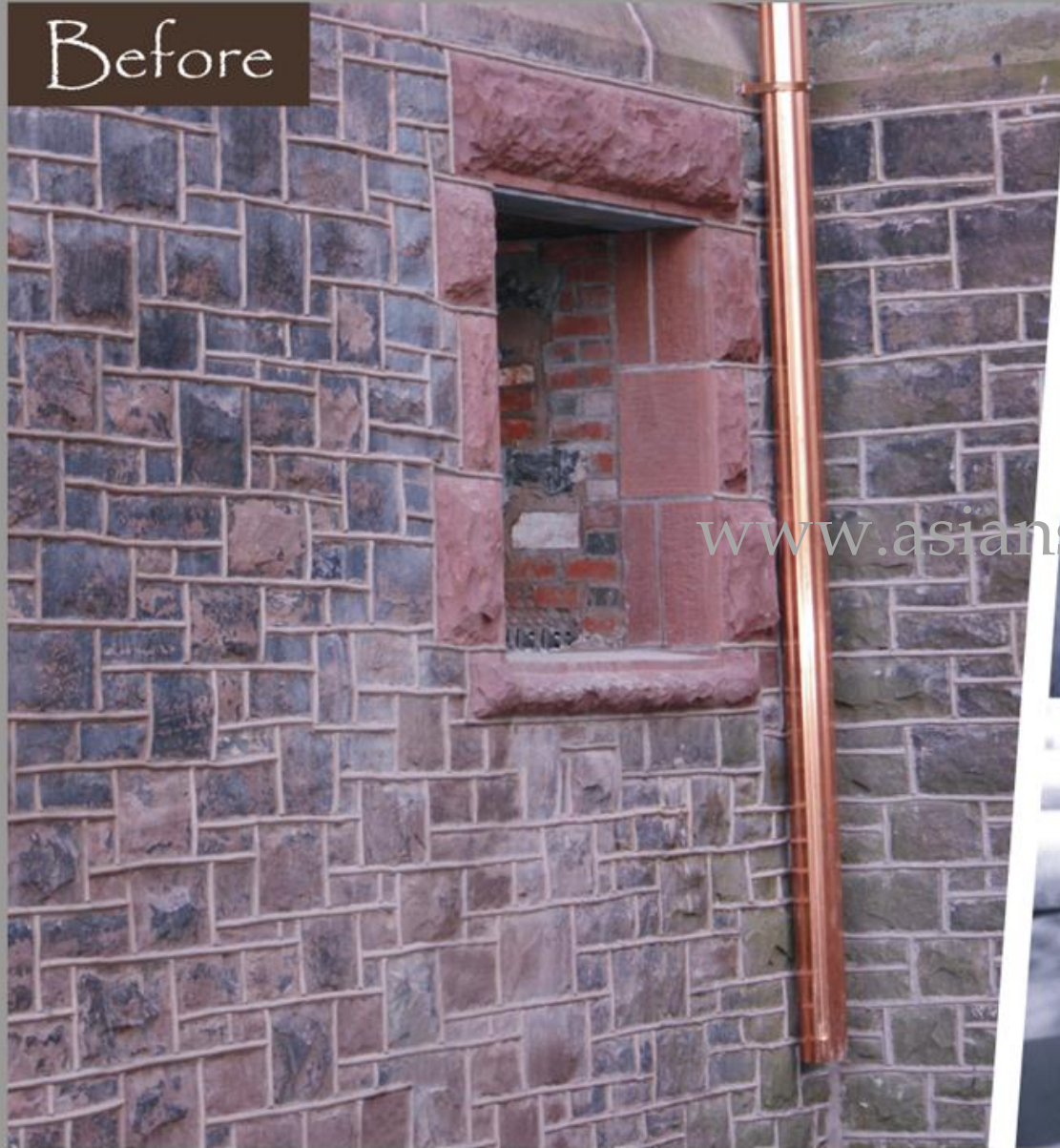

www.asianstones.com



After

Quoin and Lintel Drawing

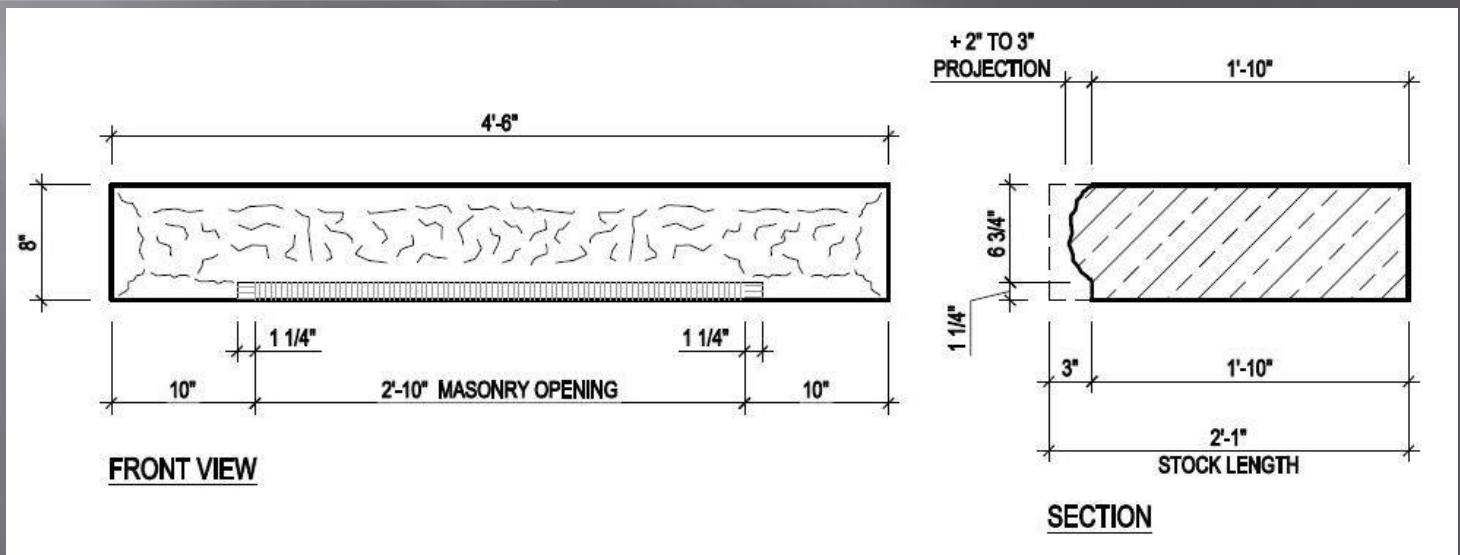
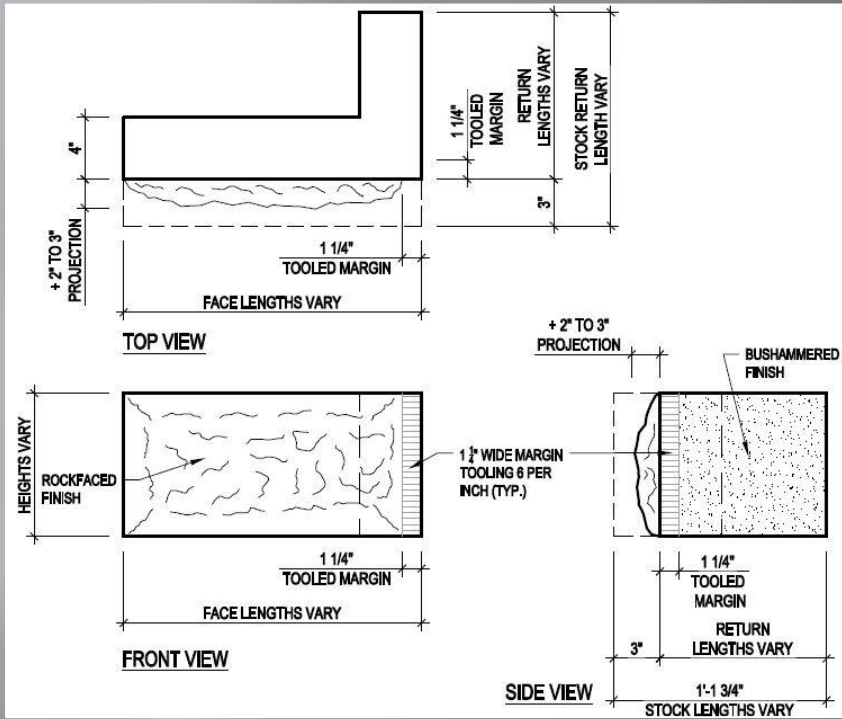

Brackets and Lintels

Before



www.asianstones.com



After

Bracket Drawing

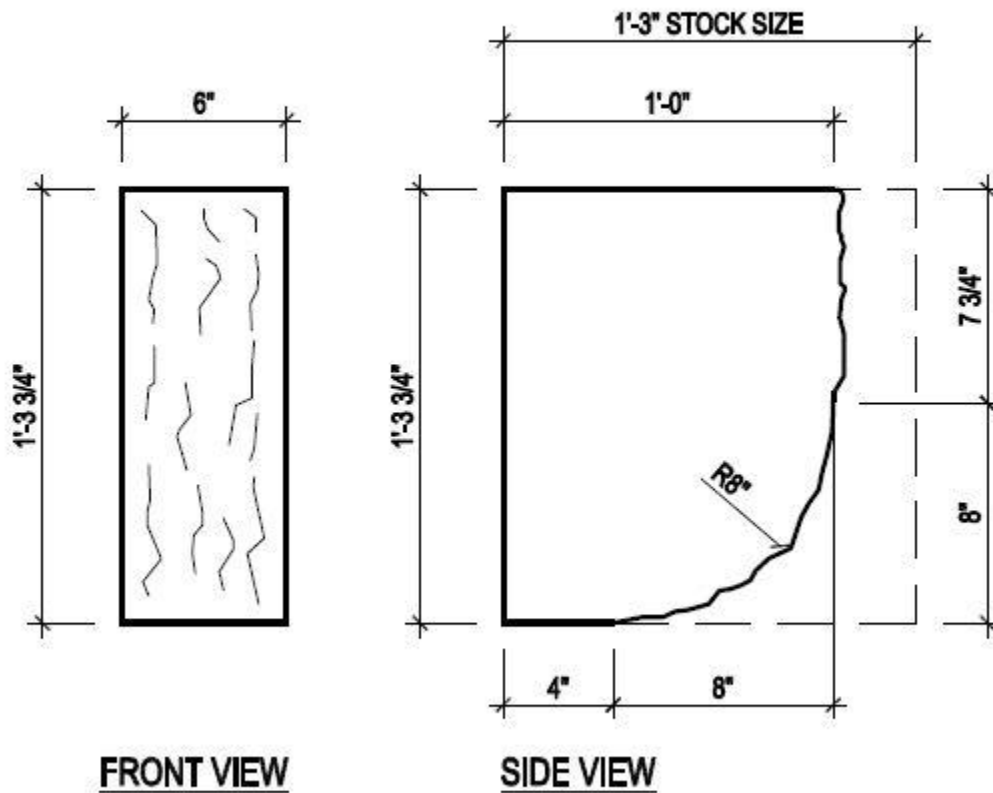

Keystones

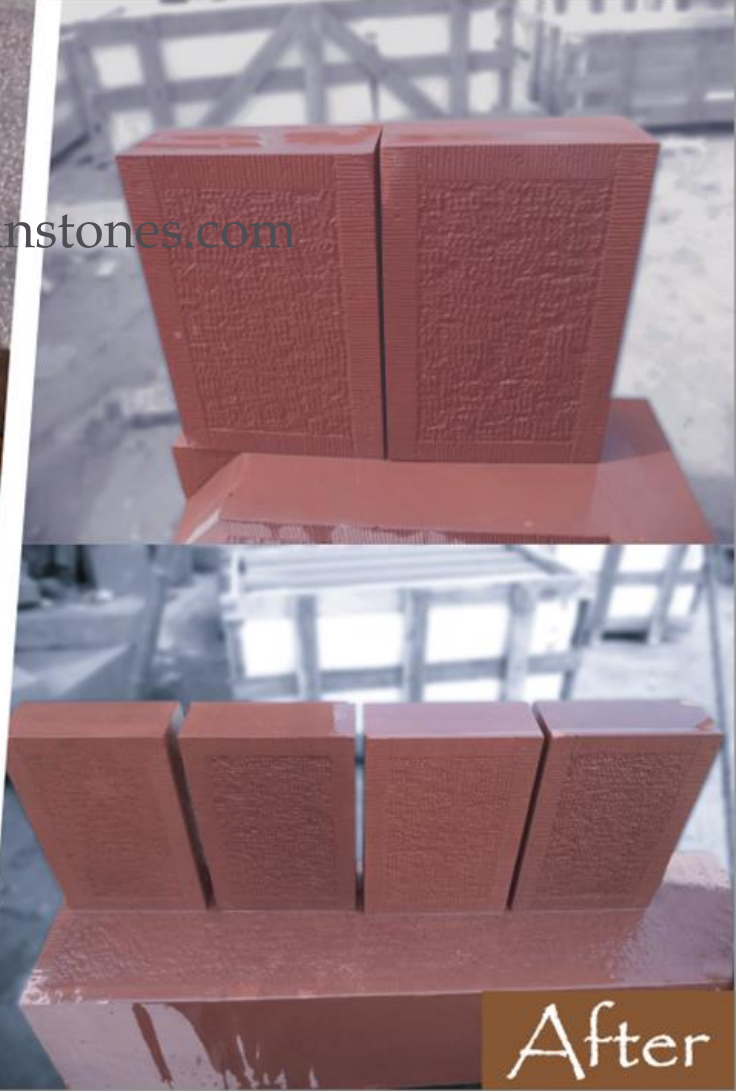

Keystone Drawing

